

Product Features:

- Hot pluggable
- N+1 Redundancy
- Automatic battery charging
- Controlled, measured and reported by TCP/IP (SNMP), RS232 (GUI)
- Modular design for accommodating high power applications
- Low voltage disconnect for the battery protection (BLVD)

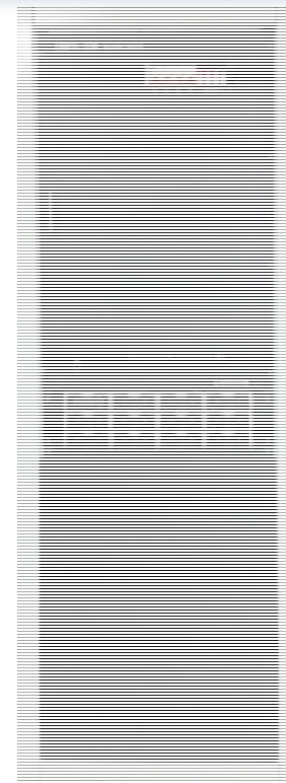
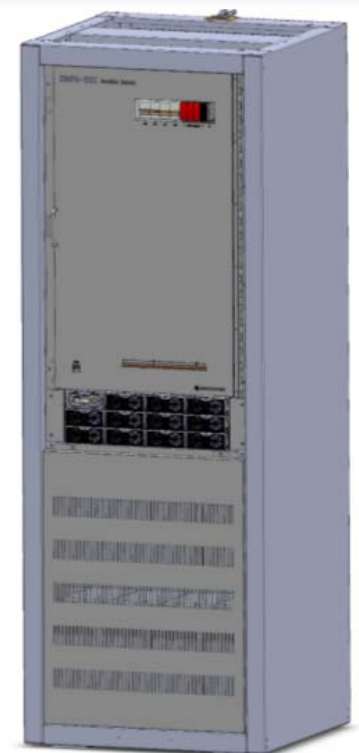

Input Specifications:

VOLTAGE	1P3W 230VAC or 3P4W 380VAC ±20% (Nominal)
FREQUENCY	45-66Hz
PROTECTION	Under & Over voltage
EFFICIENCY	96.0% Max (3kW module)

Output Specifications:

VOLTAGE	Default -53.5VDC
CURRENT	610.5A Max (3KW 11 modules)
ADJUSTMENT RANGE	-42VDC~-58VDC
LINE REGULATION	±0.5% Max
LOAD REGULATION	±1.0% Max
TEMP REGULATION	±0.5% Max
RIPPLE & NOISE	≤ 300mVp-p
SETPOINT ACCURACY	±0.5%
OVER CURRENT	101~110%
PROTECTION	-59VDC over (recycle input to reset) Thermal Shutdown Battery Temp. Compensation

Status & Control signal:

COMMUNICATION- INTERFACE	RS232, TCP/IP Digital In&Output Alarm(8ports)
-----------------------------	--

General Specifications:

OPERATING TEMP	-40°C to +75°C, (Derating above +45°C)
STORAGE TEMP	-40°C ~ +80°C
OPERATING HUMIDITY	0% ~ 95%(Non-Condensing)
STORAGE HUMIDITY	0% ~ 95%(Non-Condensing)
COOLING	Fan cooling
ALTITUDE	2,000Meter
SIZE (W×D×H)	650mm X 615mm X 1800mm

Electromagnetic Compatibility: (TBD)

EMISSIONS	EN61204/EN55022 Class A
HARMONIC CURRENT - EMISSIONS	EN61000-3-2
FLUCTUATIONS & FLICKER	EN61000-3-3
ELECTROSTATIC -DISCHARGE	EN61000-4-2
RADIATED EFI	EN61000-4-3
EFT/BURSTS	EN61000-4-4
SURGE TRANSIENTS	EN61000-4-5
CONDUCTED IMMUNITY	EN61000-4-6
VOLTAGE DIPS AND - SHORT INTERRUPTIONS	EN61000-4-11

Standards & Approvals: (TBD)

UL/CUL	60950-1
--------	---------



NESPACE-48/3K

(3KW Rectifier Module)

the
POWER
you need

High Efficiency Rectifier Module

NESPACE-48/3K

Rectifier Module
54VDC / 3000W

Product Features:

- Modular Design
- 1U Rack Mountable
- World Wide Safety Approval
- DSP Controller
- LED alarm indicated
- Hot pluggable
- Energy saving operation



Input Specifications:

VOLTAGE	1Ø240VAC (85VAC ~ 297VAC) (Nominal 176~275Vac)
FREQUENCY	45-66Hz
INRUSH CURRENT	25A @ 240VAC
PROTECTION	Mains fuse in both lines
LEAKAGE	3.5mA Max @ 240VAC
EFFICIENCY	96.0% Max
POWER FACTOR	> 0.98 at 50% load or more
PROTECTION	Input Under voltage, Overvoltage

General Specifications:

OPERATING TEMP	-40°C to +75°C, (Derating above +45°C)
STORAGE TEMP	-40°C to +85°C
OPERATING HUMIDITY	0% to 95% (Non-Condensing)
STORAGE HUMIDITY	5% to 95% (Non-Condensing)
COOLING	Controlled Fan in a module
ACOUSTIC NOISE	≤58dBA at nominal input and full load
RELIABILITY	>350,000 Hrs MTBF (Ambient : 25°C)
SIZE (W×D×H)	108mm × 340mm × 44mm

Output Specifications:

VOLTAGE	54.0VDC
CURRENT	55.5A (Max 3KW)
ADJUSTMENT RANGE	42.0~58.0VDC
LINE REGULATION	±0.5% Max over entire input range
LOAD REGULATION	±0.5% Maximum
TEMP REGULATION	±0.5% Maximum
Overall REGULATION	±5.0% Maximum
RIPPLE	≤ 300mVp-p(3KW)
SETPPOINT ACCURACY	±0.5%
OVER VOLTAGE PROTECTION	59VDC (recycle input to reset) Power derated, Thermal Shutdown

Electromagnetic Compatibility:

EMISSIONS	EN55022 Level A (Conducted)
ELECTROSTATIC DISCHARGE	EN61000-4-2, 4KV Contact / 8KV Air
RADIATED SUSCEPTIBILITY	EN61000-4-3, 26-1000MHz, 10V/M, 80%AM
EFT/BURSTS	EN61000-4-4, 2KV
SURGE	EN61000-4-5
CONDUCTED IMMUNITY	EN61000-4-6, 0.15-800MHz, 10V 80%
VOLTAGE DIPS	EN61000-4-10, 95% Dip&10ms, 30% Dip&500ms
VOLTAGE INTERRUPTIONS	EN61000-4-11, 95% reduction, 5ms
FLUCTUATIONS & FLICKER	EN61000-3-3

Status & Control signals:

COMMUNICATION CAN

Standards & Approvals:

UL, CE, CB



DONGAH ELECOMM
www.dongahelcomm.co.kr
www.dongahusa.com

DongAh Elecomm Corp.
134-14, Nampyeong-ro, Yangji-myun, Cheoin-gu,
Yongin-si, Kyunggi-do, 17162 Korea

Tel : +82-31-330-5500
Fax : +82-31-330-9040

AC Input:

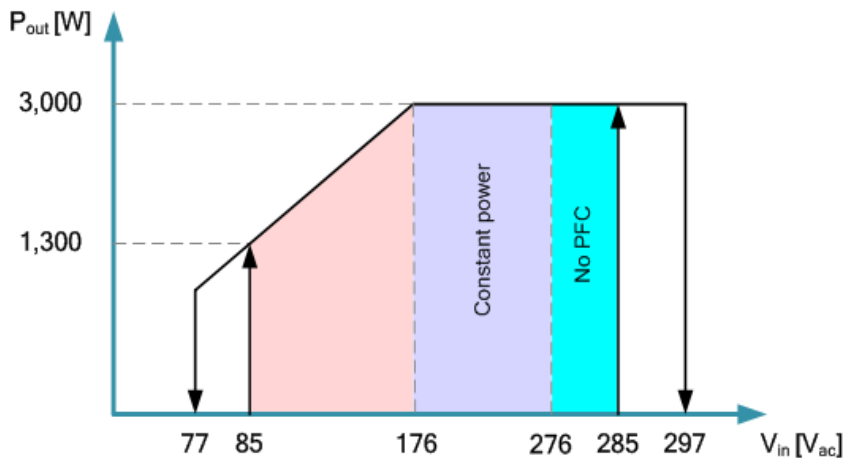

- Voltage range : 85Vac ~ 297Vac
- Constant power range (Max 3KW) : 176Vac~ 297Vac
- Shut-down. Voltage
 - OVP : 297Vac (recovery 285Vac)
 - UVP : 77Vac (recovery 85Vac)

DC Output:

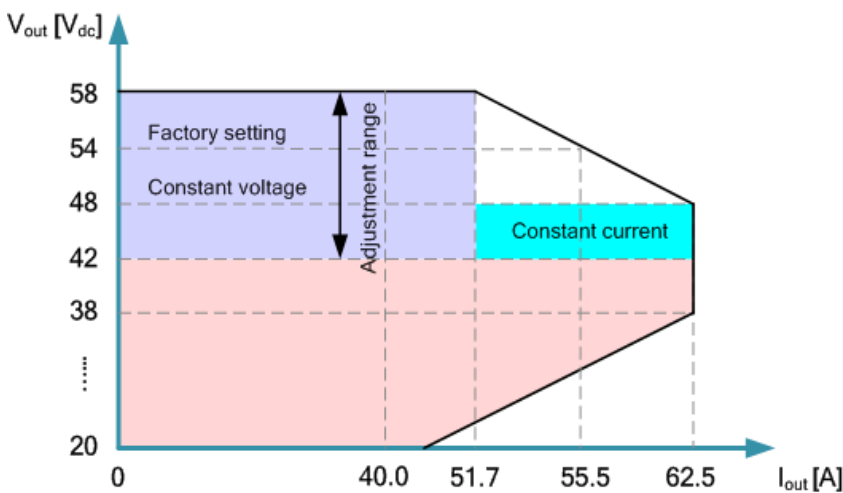

- Voltage range : -42.0Vdc ~ -58.0Vdc
- Constant power range (Max 3KW) : -48.0Vdc ~ -54.0Vdc

Temperature:

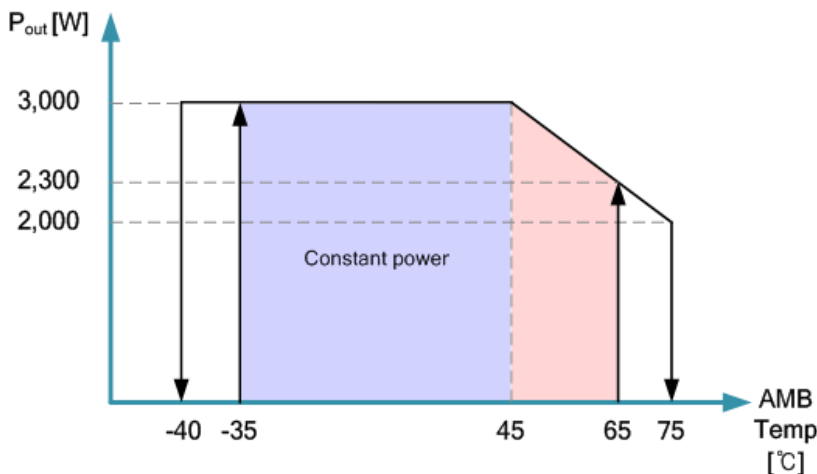

- Operating temperature : -40°C ~ 75°C
- Constant power range (Max 3KW) : -40°C ~ 45°C
- Shut-down. Temperature (Tolerance: ±5°C)
 - : 75°C (recovery 65°C)
 - : -40°C (recovery -35°C)



Product Features :

- RS 232 interface for PC connection, TCP/IP, SNMP V1, SNMP V2C
- Adjustable Output Voltage
- AC Input High/Low Voltage Alarm

Display :

- Status of the rectifier system is displayed on the LCD :
 - Output voltage/Input voltage
 - Output load current
 - Rectifier Temperature
 - Rectifier system setup value and alarms
 - Display output currents for individual rectifier modules

Analog Measurements (Tolerance : Full Scale $\pm 0.5\%$) :

- Rectifier input AC voltage
- Rectifier output DC voltage
- Rectifier load current
- Rectifier temperature

Controller Unit Function :

- Failure of the rectifier controller shall not affect the operation of the rectifiers in the system
 - Store and display 1,000 event alarm logs & 1,000 data logs
 - †Digital Input Alarm (User Defined alarms)
 - †Dry Contact Alarm (User Defined alarms)
- † : The number of alarm can vary depending on the shelf

Battery Managements :

- Battery charge/discharge current/the battery set and the total output/
Battery Temperature Display and Measurement
- Manual/Float/Equal charging mode exchangeable
- Battery Charging Current Limiting
- Temperature Compensated Charge Voltage for increased battery Lifetime
- Setting of Battery Temperature Compensation Curve

CPU :

- Coretex-M4 Core
- CPU Clock – Up to 150MHz
- 32ch DMA, 16KB cache, DSP, floating-point unit
- Memory
: Flash 1MB / RAM128KB / EEPROM
/ Flax RAM, Flax NVM
- Ethernet, UART, RS485
- Support RTOS

Interface :

- RS232
 - Baud Rate : 115,200 bps
 - Data Bits : 8Bit / Stop Bits : 1Bit / Parity Bits : N
- LAN
 - Hardwired TCP/IP protocol(TCP/UDP/ICMP/Ethernet)
 - 10BaseT/100BaseTX Ethernet MAC/PHY Embedded
 - Auto Negotiation(Full and half duplex, 10/100-Based)
 - Auto MDI/MDIX(Straight-through or Crossover)



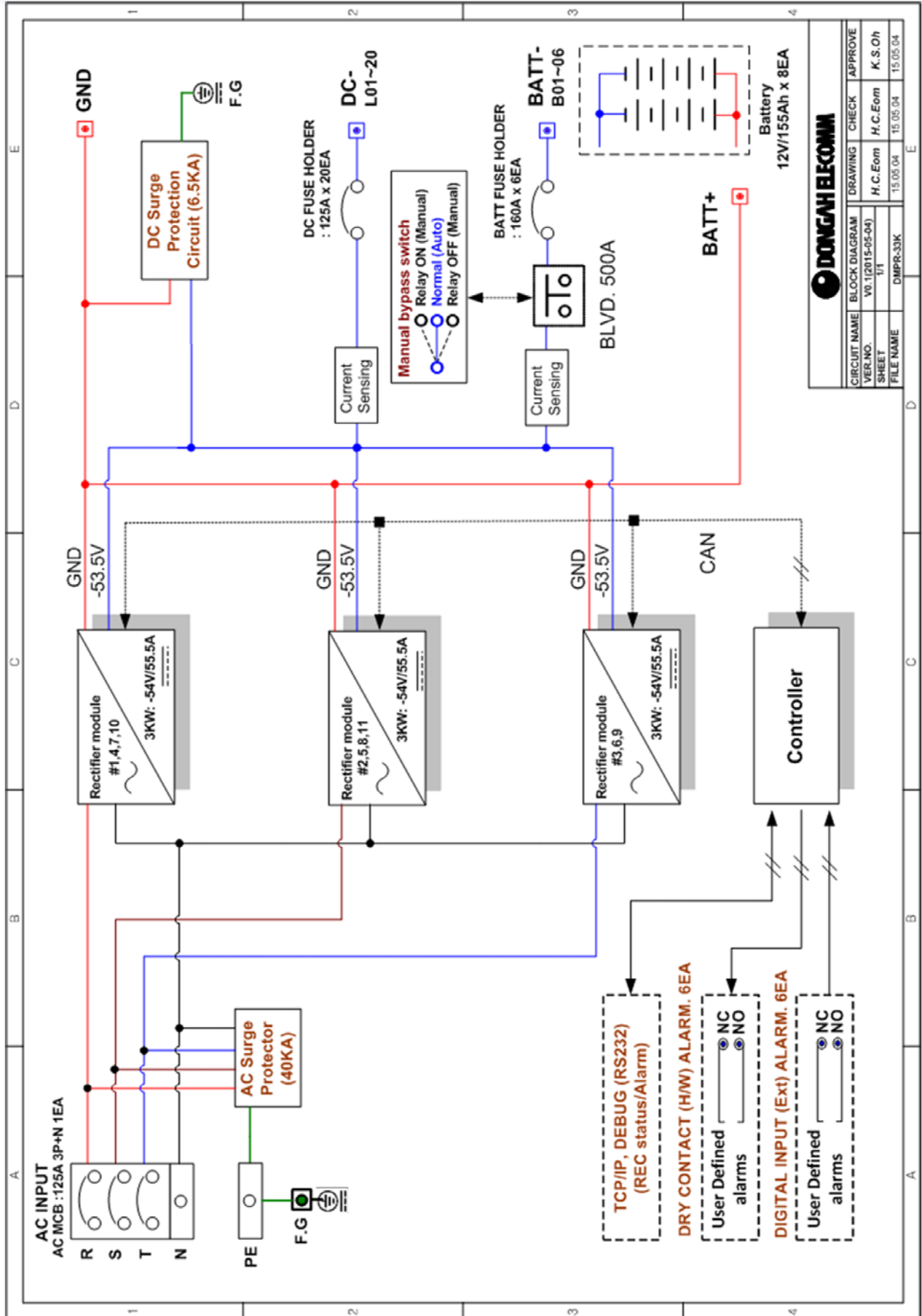

DONGAH ELECOMM	
CIRCUIT NAME	BLOCK DIAGRAM
VER.NO.	V0.1(2015-05-04)
SHEET	1/1
FILE NAME	DMPPR-31K
DRAWING	CHECK
H.C.Eom	H.C.Eom
15.05.04	15.05.04
APPROVE	K.S.Oh
	15.05.04



DMPR-33K (Rack type)

the **POWER**
you need

Configuration

Front View: (Door open)

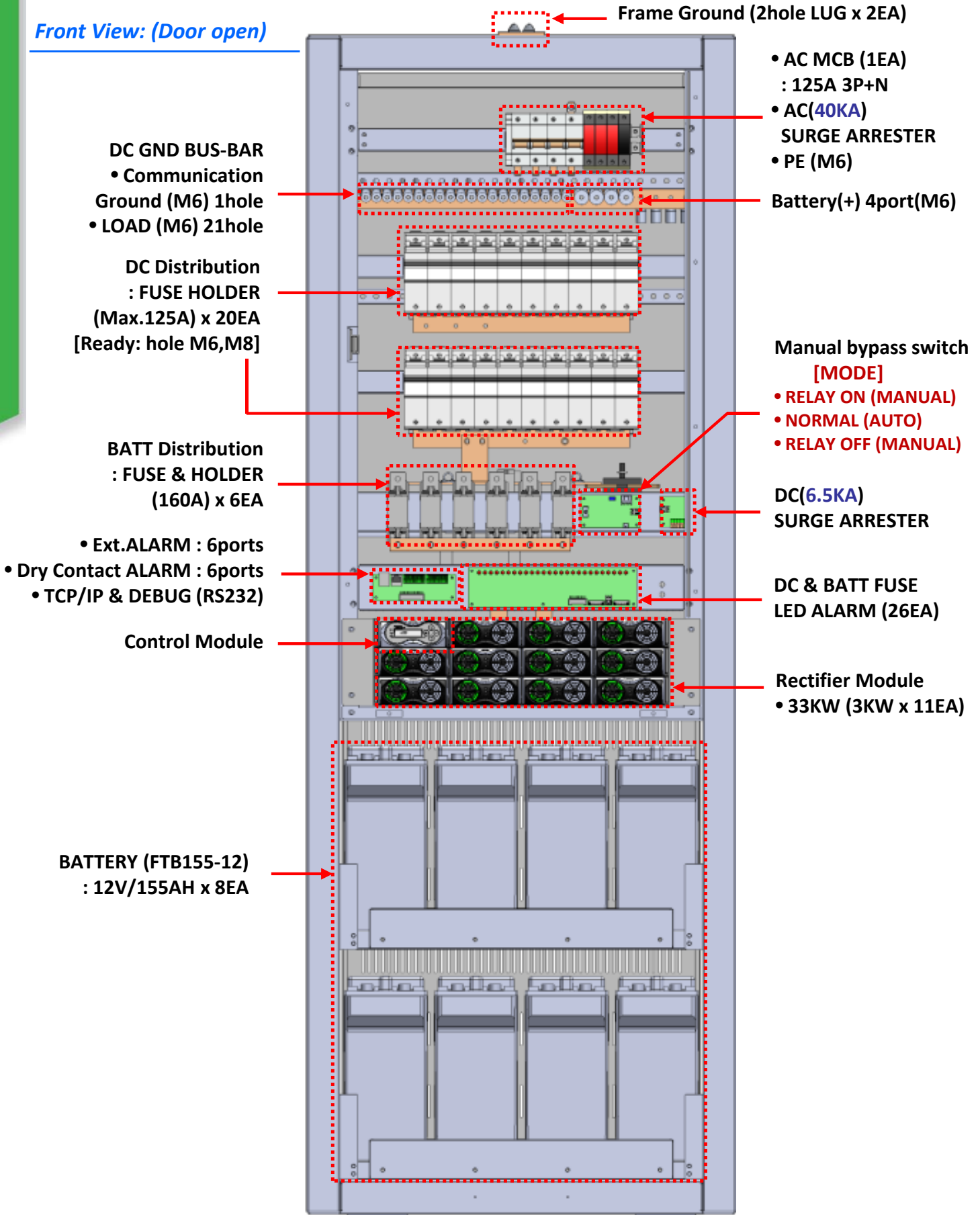

DONGAH ELECOMM
www.dongahelcomm.co.kr
www.dongahusa.com

DongAh Elecomm Corp.
134-14, Nampyeong-ro, Yangji-myun, Cheoin-gu,
Yongin-si, Kyunggi-do, 17162 Korea

Tel : +82-31-330-5500
Fax : +82-31-330-9040

DMPR-33K (Rack type)

the
POWER
you need

Configuration

Rear Side View: (Door close)

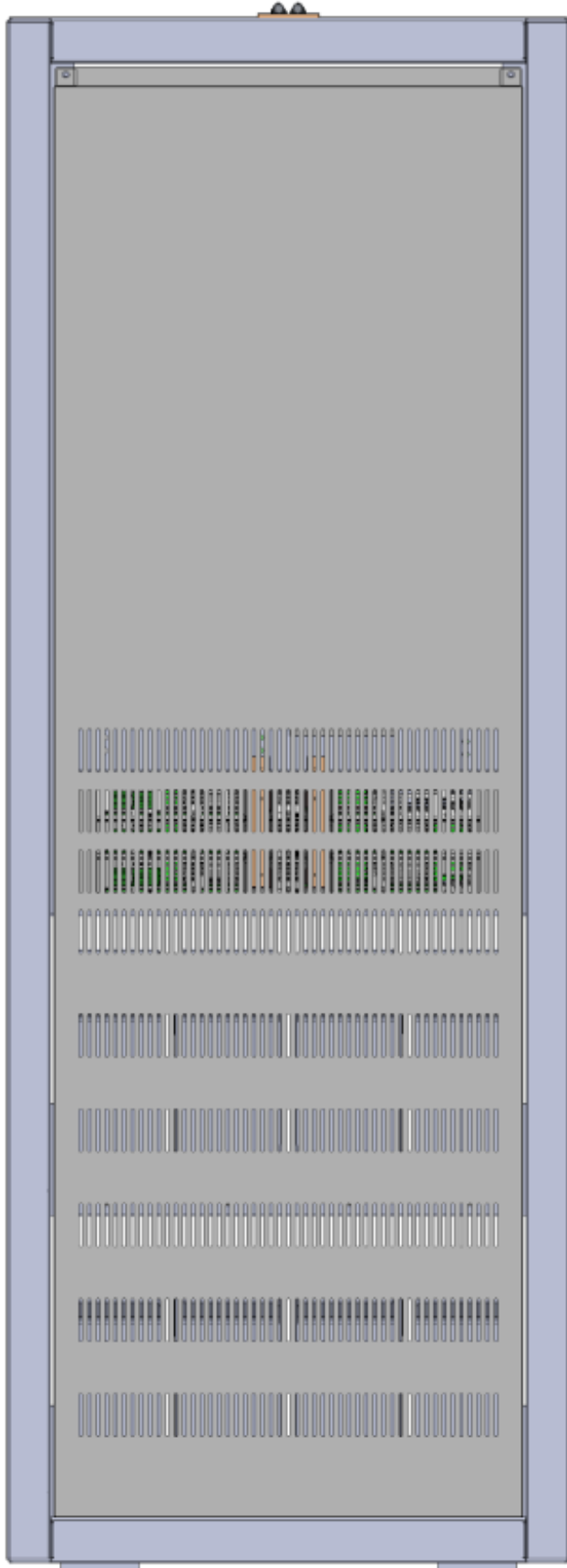

Rear Side View: (Door open)

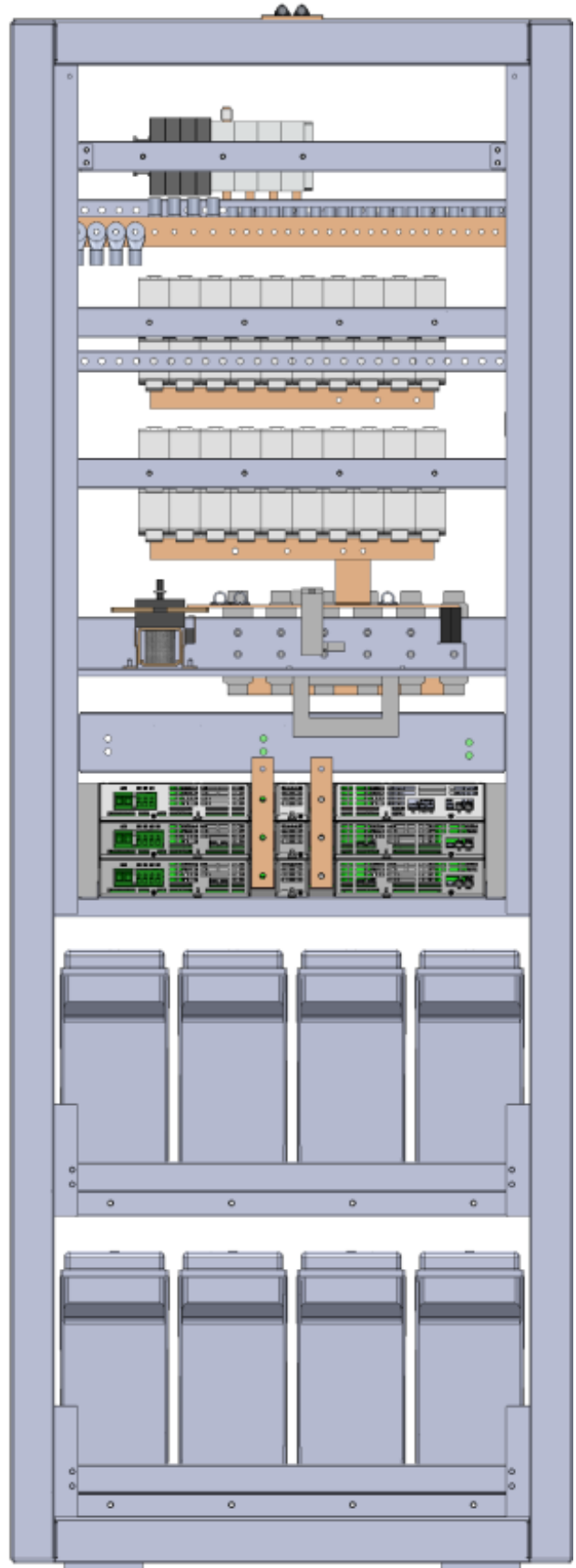

DONGAH ELECOMM
www.dongahelcomm.co.kr
www.dongahusa.com

DongAh Elecomm Corp.
134-14, Nampyeong-ro, Yangji-myun, Cheoin-gu,
Yongin-si, Kyunggi-do, 17162 Korea

Tel : +82-31-330-5500
Fax : +82-31-330-9040